

KURTTEKİN®



FOR INDUSTRIAL PIPING



**CONSTANT & VARIABLE TYPE
SPRING HANGERS & SUPPORTS**

Kurttekin Ltd. Şti.
Cumhuriyet Caddesi 12/2 81570 Küçükyalı İSTANBUL - TÜRKİYE
Tel.: 216.3886247 Fax.: 216.3886248 Gsm.: 532.2534851
e-posta : kurttekin@kurttekin.com
web sayfası : <http://www.kurttekin.com>

VARIABLE LOAD TYPE SPRING HANGERS & SUPPORTS

Variable Load Type Spring Hangers and Supports are used for supporting and carrying the pipeline at required spans, without preventing the vertical movement of the pipe subject to thermal changes. There is a wide range of application, the only restriction being the range of travel. Since the pipe load is carried directly by the spring, the vertical travel of pipe during operation causes a variation in the reaction force exerted by the spring. The calculated Operation Load and travel are used in choosing the Load Group and travel group of the unit. The Cold set load thus found according to the performance characteristics of the selected unit is the pre-set pinning load. In choice, care should be taken to keep the percent of load variation with respect to Operation Load to be below 25 %.

Units are manufactured to satisfy various load groups as shown in the Selection Chart, having three different travel ranges. K, O and U travel ranges specify 35 mm, 70 mm and 140 mm of travel respectively. Type letters A, B, C, D, F and G represent the various modes of connection the hanger or support is placed, with respect to the main structural frame. These are sketched on the following pages.

The Supports and Hangers are equipped with restrictions against overload and overtravel. Units are delivered as pre-set pinned in accordance with the Cold Set Load. The Load Indicators on the outer pipe indicate the Load and travel position with respect to the preset value. There is no need for inspection and maintenance.

Springs are designed and manufactured according to TS 1440 and TS 1441, the materials complying with DIN 17221, DIN 17222 and DIN 17223. All units are factory tested and marked accordingly. Provided properly used within the load and travel limits shown on the Indicator label, each unit is guaranteed for two years or 10,000 hours of operation starting from date of delivery.

ORDERING EXAMPLE:

XX . X . X

Where;

The number in the first two digits represent the Load Group,

the letter in the third digit represents the travel range (K, O, U)

the letter on the fourth digit represents the type of connection (A, B, C, D, F or G)

For any requirement that cannot be fitted in the Selection Chart please consult our engineers for special design and alternative solutions. Please also note that the dimensions given here onto are not binding and we reserve the right to make any alterations we may deem necessary, without altering the performance characteristics.

MAIN TYPES

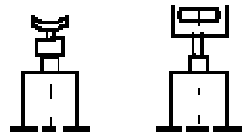
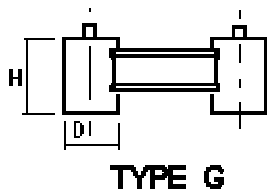
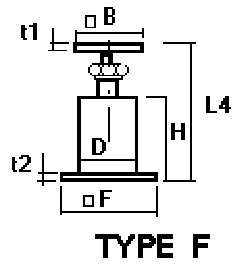
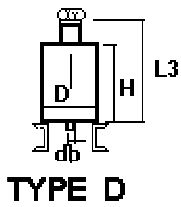
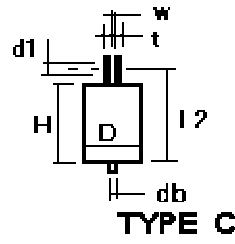
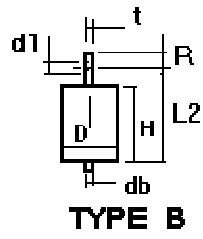
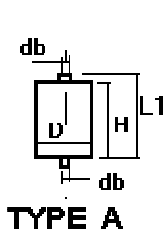

SELECTION CHART FOR VARIABLE LOAD TYPE SPRING HANGERS & SUPPORTS
DEĞİŞKEN YÜK TİPİ YAYLI ASKI VE DESTEKLER İÇİN SEÇME ABAĞI

0	1	2	3	4	5	6	7	8	9	10	11	12	13	14	15	16	17	18	19	20	K	O	U	
23,3	33,0	42,2	55,0	70,4	96,8	132	176	238	312	405	528	704	942	1258	1698	2658	3142	4180	5562	7392	0	0	0	
23,9	33,8	43,2	56,3	72,0	99,0	135	180	243,4	319,1	414,2	540	720	963	1287	1737	2712	3213	4275	5688	7560	1	2	4	
24,4	34,5	44,2	57,5	73,6	101,2	138	184	248,8	326,2	423,4	552	736	985	1315	1775	2765	3285	4370	5815	7728	2	4	8	
24,9	35,3	45,1	58,8	75,2	103,4	141	188	254,2	333,3	432,6	564	752	1006	1344	1814	2819	3356	4465	5941	7896	3	6	12	
25,4	36,0	46,1	60,0	76,8	105,6	144	192	259,6	340,4	441,8	576	768	1028	1372	1852	2872	3428	4560	6068	8064	4	8	16	
26,0	36,8	47,0	61,3	78,4	107,8	147	196	265	347,5	451	588	784	1049	1401	1891	2926	3499	4655	6194	8232	5	10	20	
26,5	37,5	48,0	62,5	80,0	110,0	150	200	270,4	354,6	460,2	600	800	1070	1430	1930	2980	3570	4750	6320	8400	6	12	24	
27,0	38,3	49,0	63,8	81,6	112,2	153	204	275,8	361,7	469,4	612	816	1092	1458	1968	3033	3642	4845	6447	8568	7	14	28	
27,6	39,0	49,9	65,0	83,2	114,4	156	208	281,2	368,8	478,6	624	832	1113	1487	2007	3087	3713	4940	6573	8736	8	16	32	
28,1	39,8	50,9	66,3	84,8	116,6	159	212	286,6	375,9	487,8	636	848	1135	1515	2045	3140	3785	5035	6700	8904	9	18	36	
28,6	40,5	51,8	67,5	86,4	118,8	162	216	292	383	497	648	864	1156	1544	2084	3194	3856	5130	6826	9072	10	20	40	
29,2	41,3	52,8	68,8	88,0	121,0	165	220	297,4	390,1	506,2	660	880	1177	1573	2123	3248	3927	5225	6952	9240	11	22	44	
29,7	42,0	53,8	70,0	89,6	123,2	168	224	302,8	397,2	515,4	672	896	1199	1601	2161	3301	3999	5320	7079	9408	12	24	48	
30,2	42,8	54,7	71,3	91,2	125,4	171	228	308,2	404,3	524,6	684	912	1220	1630	2200	3355	4070	5415	7205	9576	13	26	52	
30,7	43,5	55,7	72,5	92,8	127,6	174	232	313,6	411,4	533,8	696	928	1242	1658	2238	3408	4142	5510	7332	9744	14	28	56	
31,3	44,3	56,6	73,8	94,4	129,8	177	236	319	418,5	543	708	944	1263	1687	2277	3462	4213	5605	7458	9912	15	30	60	
31,8	45,0	57,6	75,0	96,0	132,0	180	240	324,4	425,6	552,2	720	960	1284	1716	2316	3516	4284	5700	7584	10080	16	32	64	
32,3	45,8	58,6	76,3	97,6	134,2	183	244	329,8	432,7	561,4	732	976	1306	1744	2354	3569	4356	5795	7711	10248	17	34	68	
32,9	46,5	59,5	77,5	99,2	136,4	186	248	335,2	439,8	570,6	744	992	1327	1773	2393	3623	4427	5890	7837	10416	18	36	72	
33,4	47,3	60,5	78,8	100,8	138,6	189	252	340,6	446,9	579,8	756	1008	1349	1801	2431	3676	4499	5985	7964	10584	19	38	76	
33,9	48,0	61,4	80,0	102,4	140,8	192	256	346	454	589	768	1024	1370	1830	2470	3730	4570	6080	8090	10752	20	40	80	
34,5	48,8	62,4	81,3	104,0	143,0	195	260	351,4	461,1	598,2	780	1040	1391	1859	2509	3784	4641	6175	8216	10920	21	42	84	
35,0	49,5	63,4	82,5	105,6	145,2	198	264	356,8	468,2	607,4	792	1056	1413	1887	2547	3837	4713	6270	8343	11088	22	44	88	
35,5	50,3	64,3	83,8	107,2	147,4	201	268	362,2	475,3	616,6	804	1072	1434	1916	2586	3891	4784	6365	8469	11256	23	46	92	
36,0	51,0	65,3	85,0	108,8	149,6	204	272	367,6	482,4	625,8	816	1088	1456	1944	2624	3944	4856	6460	8596	11424	24	48	96	
36,6	51,8	66,2	86,3	110,4	151,8	207	276	373	489,5	635	828	1104	1477	1973	2663	3998	4927	6555	8722	11592	25	50	100	
37,1	52,5	67,2	87,5	112,0	154,0	210	280	378,4	496,6	644,2	840	1120	1498	2002	2702	4052	4998	6650	8848	11760	26	52	104	
37,6	53,3	68,2	88,8	113,6	156,2	213	284	383,8	503,7	653,4	852	1136	1520	2030	2740	4105	5070	6745	8975	11928	27	54	108	
38,2	54,0	69,1	90,0	115,2	158,4	216	288	389,2	510,8	662,6	864	1152	1541	2059	2779	4159	5141	6840	9101	12096	28	56	112	
38,7	54,8	70,1	91,3	116,8	160,6	219	292	394,6	517,9	671,8	876	1168	1563	2087	2817	4212	5213	6935	9228	12264	29	58	116	
39,2	55,5	71,0	92,5	118,4	162,8	222	296	400	525	681	888	1184	1584	2116	2856	4266	5284	7030	9354	12432	30	60	120	
39,8	56,3	72,0	93,8	120,0	165,0	225	300	405,4	532,1	690,2	900	1200	1605	2145	2895	4320	5355	7125	9480	12600	31	62	124	
40,3	57,0	73,0	95,0	121,6	167,2	228	304	410,8	539,2	699,4	912	1216	1627	2173	2933	4373	5427	7220	9607	12768	32	64	128	
40,8	57,8	73,9	96,3	123,2	169,4	231	308	416,2	546,3	708,6	924	1232	1648	2202	2972	4427	5498	7315	9733	12936	33	66	132	
41,3	58,5	74,9	97,5	124,8	171,6	234	312	421,6	553,4	717,8	936	1248	1670	2230	3010	4480	5570	7410	9860	13104	34	68	136	
41,9	59,3	75,8	98,8	126,4	173,8	237	316	427	560,5	727	948	1264	1691	2259	3049	4534	5641	7505	9986	13272	35	70	140	
																						TYPE/TIP		
0.53	0.75	0.96	1.25	1.6	2.2	3	4	5.4	7.1	9.2	12	16	21.4	28.6	38.6	53.6	71.4	95	126.4	168	K			
0.26	0.37	0.48	0.62	0.8	1.1	1.5	2.1	2.7	3.55	4.6	6	8	10.7	14.3	19.3	26.8	35.7	47.5	63.2	84	O			
0.13	0.18	0.24	0.31	0.4	0.55	0.75	1.00	1.35	1.8	2.3	3	4	5.3	7.1	9.6	13.4	17.8	23.7	31.6	42	U			

CONSTANT LOAD TYPE SPRING HANGERS AND SUPPORTS

In applications where variable load type Spring Hangers and Supports cannot be used due to load and travel requirements, or where the reaction force of the support is required to be kept constant with respect to the vertical movement of the pipeline, Constant Load Type Spring Hangers and Supports are used. In this design the load is not carried directly by the spring. The geometry and movement arm combination is so designed that within the specific travel range the reaction force exerted by the support is CONSTANT, independent of the compression in the spring.

The geometric and connection types are shown on the following pages. The design criteria and test properties for the springs are the same as those for the springs used in the variable load type Hangers and Supports. Springs are designed and manufactured according to TS 1440 and TS 1441 , the materials complying with DIN 17221 , DIN 17222 and DIN 17223. All units are factory tested are marked accordingly. Provided properly used within the load and travel limits shown on the Indicator label, each unit is guaranteed for two years or 10.000 hours of operation starting from date of delivery.

ORDERING EXAMPLE: SA . XX. XXX. CXX . X

Where;

**SA represents Constant Load Hanger or Support,
numbers in the next two digits represent the Load Group,
numbers in the next two or three digits represent the Travel in mm,
numbers following the letter C represent the Type of location
(50,51,52....56),
the letter in the last digit represents the Type of
Connection(J,K,L,M.....ETC)**

For any requirement that cannot be fitted in the Selection Chart please consult our engineers for special design and alternative solutions. Please also note that the dimensions given here onto are not binding and we reserve the right to make any alterations we may deem necessary, without altering the performance characteristics.

SELECTION CHART FOR CONSTANT LOAD TYPE SPRING HANGERS & SUPPORTS

SABİT YÜK TİPİ YAYLI BORU ASKI VE DESTEKLERİ İÇİN SEÇİM ABAĞI

TRAVEL in mm LOAD in Kgf (Kurs mm Yük Kgf)

LOAD GROUP	1	2	3	4	5	6	7	8	9	10	11	12	13	14	15	16	17	18	19	20	21	22	23	24	25	26	
TRAVEL																											
60	47	60	76	96	122	155																					
70	40	51	65	82	105	133																					
80	35	45	57	72	92	116																					
90	31	40	50	64	82	104	132	167	213	271	343	436															
100	28	36	46	58	73	93	119	151	192	244	309	393	467	525	590	658	727	815									
110	25	32	41	53	67	85	108	137	174	221	281	357	424	478	537	598	661	741									
120	23	30	38	48	61	78	99	126	160	203	258	327	389	438	492	548	606	679	771	857	934	1017	1109	1208	1321	1455	
130	22	28	35	45	57	72	91	116	148	187	238	302	359	404	454	506	560	627	712	791	861	938	1024	1115	1219	1343	
140	20	26	33	41	52	66	85	108	137	174	221	280	333	375	422	470	520	582	661	734	799	871	952	1035	1132	1247	
150	19	24	32	39	48	62	79	100	128	162	206	261	311	351	389	439	484	543	617	685	746	813	888	966	1056	1164	
160	18	23	29	36	46	58	74	94	120	152	193	245	292	329	369	411	455	510	579	643	700	763	832	906	990	1091	
170	16	21	27	34	43	55	70	89	113	143	182	231	275	309	347	397	428	480	545	605	658	718	783	853	932	1027	
180	26	20	25	32	41	52	66	84	107	135	172	218	160	292	328	366	404	453	514	571	622	678	740	806	881	970	
190	15	19	24	31	39	49	63	80	101	128	163	207	246	277	311	347	383	429	487	541	589	642	701	763	834	919	
200	14	18	23	29	37	47	59	75	96	122	155	196	233	263	295	329	364	407	463	514	560	610	666	725	793	873	
210	14	17	22	28	35	45	57	72	91	116	147	187	222	250	281	313	346	388	441	490	533	591	634	690	755	831	
220													213	239	269	299	331	371	421	467	509	555	605	659	720	794	
230													203	229	257	287	317	355	403	447	487	531	579	630	689	759	
240													195	219	246	274	303	340	386	428	466	508	555	604	660	727	
250													187	211	237	264	291	326	371	412	447	488	533	580	634	699	
260													180	202	227	253	280	313	356	395	430	469	512	558	610	672	
270																			343	381	415	452	493	537	587	647	
280																			331	367	400	436	476	518	566	624	
290																			319	354	386	421	459	500	547	602	
300																			309	343	373	407	443	483	528	582	
310																			299	332	361	394	430	468	511	563	
320																			289	321	350	381	416	453	496	546	
330																			281	312	339	370	404	439	480	529	
340																			272	302	329	359	391	426	466	514	
350																			265	294	320	349	381	414	453	499	
360																			257	286	311	339	370	403	440	485	

SELECTION CHART FOR CONSTANT LOAD TYPE SPRING HANGERS & SUPPORTS

SABİT YÜK TİPİ YAYLI BORU ASKI VE DESTEKLERİ İÇİN SEÇİM ABAĞI

TRAVEL in mm LOAD in Kgf (Kurs mm Yük Kgf)

LOAD GROUP	27	28	29	30	31	32	33	34	35	36	37	38	39	40	41	42	43	44	45	46
TRAVEL																				
130	1507	1711	1901	2074	2260	2464	2756													
140	1400	1589	1765	1926	2099	2288	2560													
150	1306	1463	1648	1798	1959	2135	2389													
160	1224	1390	1545	1685	1836	2002	2240													
170	1153	1305	1454	1586	1729	1884	2108	2369	2606	2911	3311	3684	4016	4378	4771	5215	5822	6621	7367	8031
180	1089	1236	1374	1498	1633	1780	1991	2237	2461	2749	3127	3479	3793	4135	4506	4922	5498	6254	6958	7585
190	1031	1171	1301	1419	1547	1686	1886	2119	2332	2605	2962	3296	3593	3918	4269	4963	5209	5924	6591	7186
200	980	1122	1236	1348	1469	1602	1792	2014	2215	2475	2815	3131	3413	3722	4056	4430	4949	5628	6262	6677
210	933	1059	1177	1289	1399	1525	1706	1917	2110	2357	2680	2982	3251	3545	3863	4219	4713	5361	5964	6502
220	891	1011	1124	1226	1336	1356	1629	1831	2014	2249	2558	2846	3103	3383	3687	4028	4499	5117	5693	6206
230	852	967	1075	1172	1277	1393	1558	1751	1926	2152	2447	2723	2968	3236	3526	3852	4303	4894	5446	5906
240	816	927	1030	1123	1224	1335	1493	1678	1846	2062	2345	2609	2845	3102	3380	3692	4124	4691	5219	5689
250	784	890	989	1078	1175	1281	1433	1611	1772	1990	2251	2505	2731	2977	3244	3544	3959	4503	5010	5461
260	754	851	951	1037	1130	1232	1378	1549	1704	1903	2165	2409	2626	2863	3120	3407	3807	4330	4817	5251
270	726	824	916	999	1086	1186	1327	1492	1641	1833	2085	2320	2529	2757	3004	3282	3666	4169	4639	5057
280	700	795	883	963	1050	1144	1280	1438	1582	1767	2010	2237	2438	2658	2897	3164	3535	4020	4473	4876
290	676	767	852	930	1013	1106	1236	1389	1528	1707	1941	2160	2354	2567	2797	3055	3414	3882	4319	4708
300	653	741	824	899	980	1068	1195	1342	1477	1650	1876	2088	2276	2481	2704	1954	3299	3752	4175	4551
310	632	718	798	870	948	1034	1156	1299	1429	1596	1816	2020	2202	2401	2617	2856	3193	3631	4040	4405
320	613	695	773	843	919	1001	1120	1258	1384	1546	1759	1957	2147	2340	2535	2769	3093	3518	3914	4267
330	594	674	749	817	891	971	1086	1220	1343	1500	1706	1898	2069	2256	2408	2685	2999	3411	3795	4137
340	576	654	727	793	864	942	1054	1185	1303	1456	1656	1842	2008	2189	2386	2606	2911	3311	3684	4016
350	560	636	706	770	840	916	1024	1151	1266	1414	1608	1789	1950	2127	2318	2532	2828	3217	3579	3911
360	544	618	687	749	816	890	996	1119	1231	1375	1564	1740	1897	2068	2253	2461	2749	3127	3479	3793
370								1089	1198	1338	1521	1693	1845	2012	2192	2395	2675	3042	3385	3690
380								1060	1166	1303	1482	1648	1797	1959	2150	2332	2605	2962	3296	3593
390								1033	1136	1269	1443	1606	1751	1909	2080	2272	2538	2886	3211	3501
400								1007	1108	1237	1407	1566	1707	1861	2028	2215	2476	2815	3131	3414
410								982	1091	1207	1373	1527	1665	1816	1979	2161	2414	2745	3055	3330

MAIN TYPES

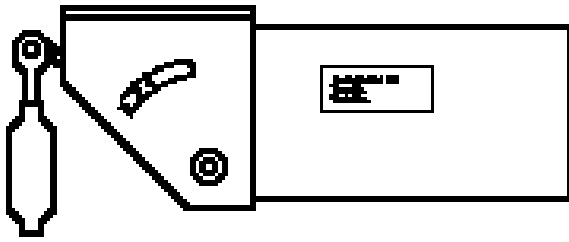

C 50

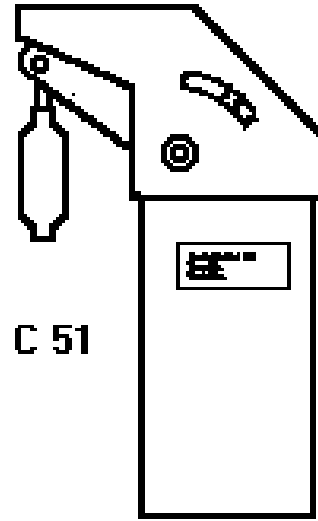

C 51

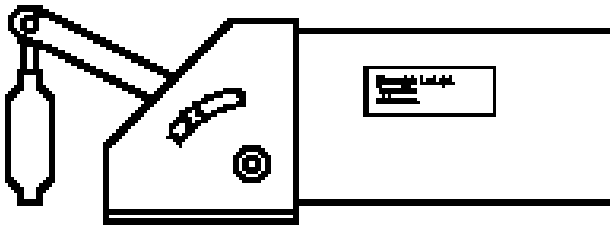

C 53

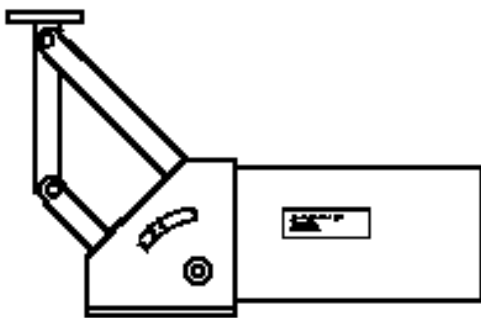

C 54



C 52

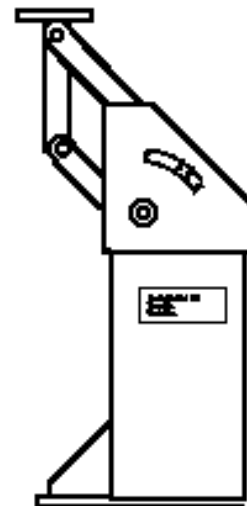

C 55

C 50

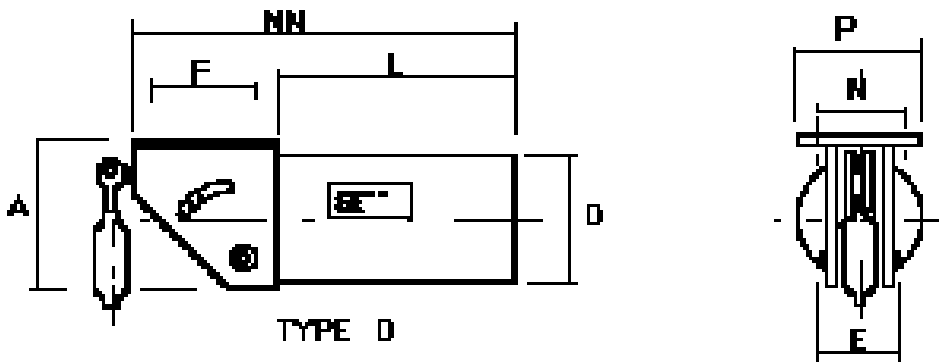
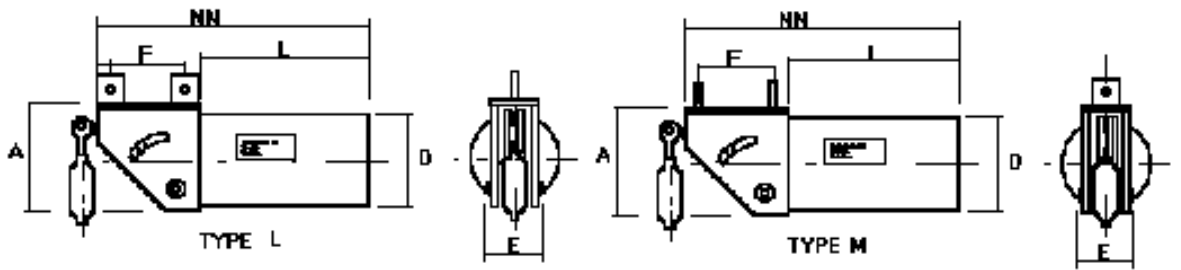
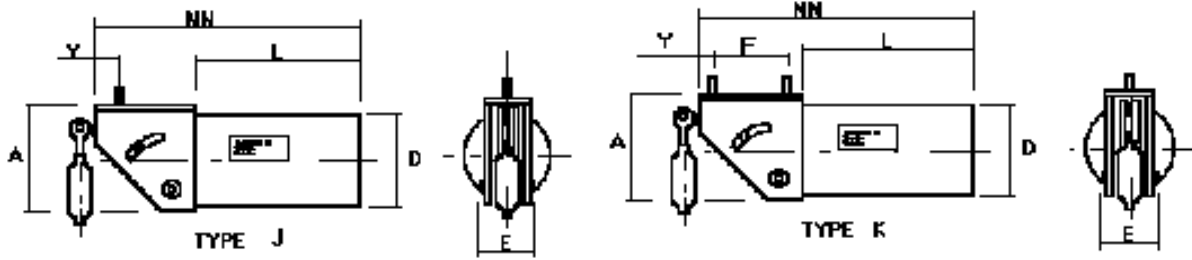

C 51

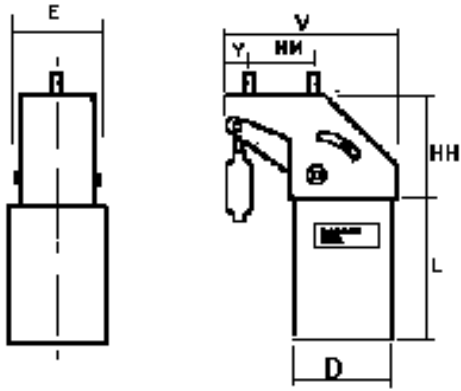

TYPE R

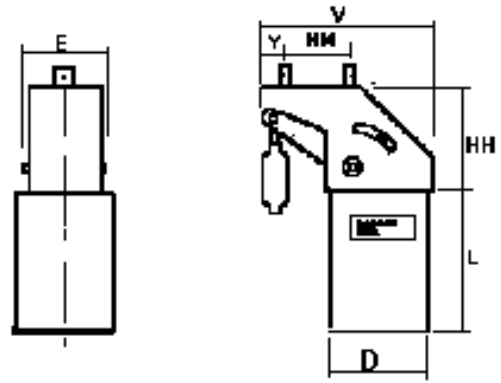

TYPE S

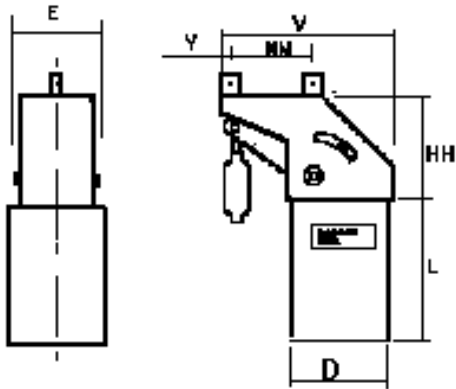

TYPE T

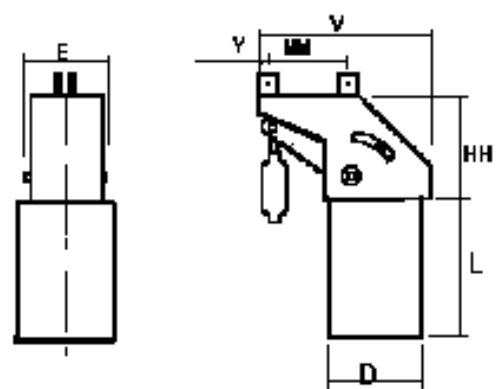

TYPE U

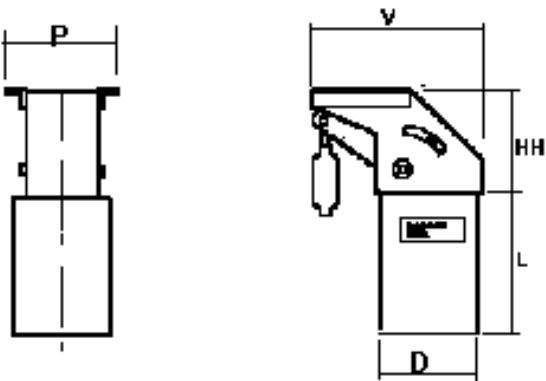

TYPE V

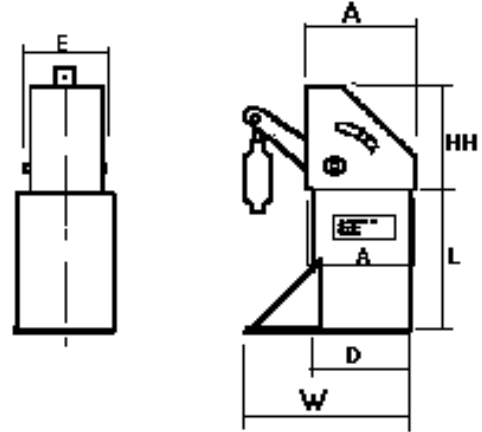

TYPE W

C 52

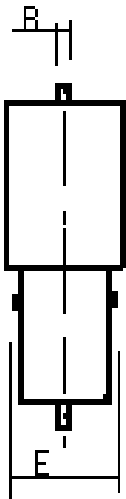

TYPE X

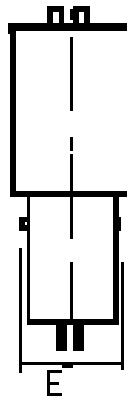

TYPE Y

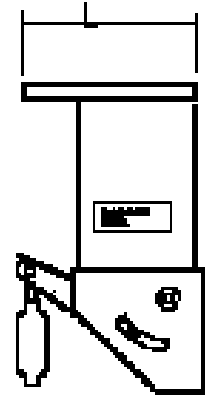

C 53

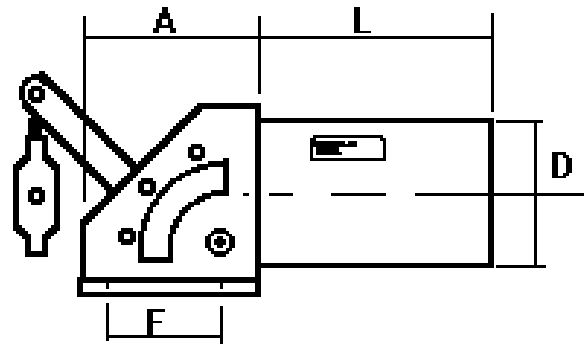
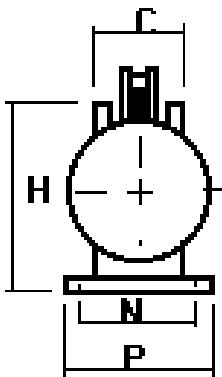

C 54

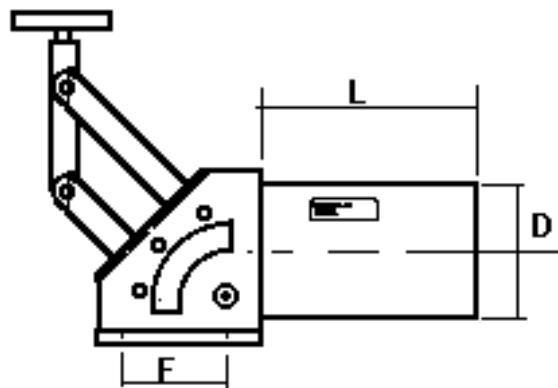
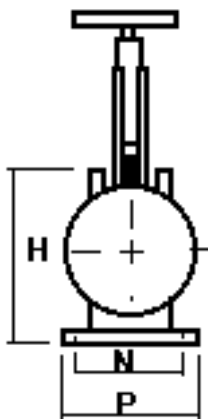

CONSTANT LOAD TYPE SPRING HANGERS & SUPPORTS							
SABİT YÜK TİPİ YAYLI BORU ASKI VE DESTEKLERİ							
Non binding dimensions (Bağlayıcı olmayan boyutlar)							
SIZE GROUP	1 to 6	7 to 12	13 to 18	19 to 26	27 to 33	34 to 39	40 to 46
D	215	275	335	395	475	550	665
L	280	330	380	445	540	640	770
A	180	216	240	260	300	350	400
E	110	120	150	185	215	250	290
N	120	130	160	200	230	270	320
P	150	160	200	250	290	330	380
S	5	5	8	10	12	16	16
F	130	166	180	210	240	290	340
NN	465	551	628	715	852	1006	1186

STUD DIMENSIONS FOR CONSTANT LOAD TYPE SPRING HANGERS & SUPPORTS								
SABİT YÜK TİPİ YAYLI ASKI VE DESTEKLERİ İÇİN SAPLAMA BOYUTLARI								
Load Group/Yük Grubu	1 to 6	7 to 12	13 to 18	19 to 26	27 to 33	34 to 39	40 to 46	47 to 50
Travel/Kurs								
40	12	20						
50	12	16						
60	12	16	20	30				
70	12	16	20	30	36			
80	12	12	20	24	36			
90	12	12	16	24	36	48		
100	12	12	16	24	30	42		
110	12	12	16	24	30	42	56	80
120	12	12	16	20	30	42	56	72
130	12	12	16	20	30	42	56	72
140	12	12	16	20	30	36	56	72
150	12	12	16	20	30	36	48	64
160	12	12	16	20	24	36	48	64
170	12	12	12	20	24	36	48	64
180	12	12	12	16	24	36	48	64
190	12	12	12	16	24	30	48	64
200	12	12	12	16	24	30	42	56
210	12	12	12	16	24	30	42	56
220				16	24	30	42	56
230				16	24	30	42	56
240				16	20	30	42	56
250				16	20	30	42	56
260				16	20	30	42	56
270				16	20	30	36	48
280				16	20	30	36	48
290				16	20	30	36	48
300				16	20	30	36	48
310				16	20	24	36	48
320				16	20	24	36	48
330				12	20	24	36	48
340				12	20	24	36	48
350				12	20	24	36	42
360				12	20	24	36	42
370						24	36	42
380						24	30	42
390						24	30	42
400						24	30	42
410						24	30	42

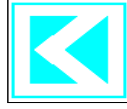

KURTTEKİN®

SWAY BRACE DARBE SÖNÜMLEYİCİ

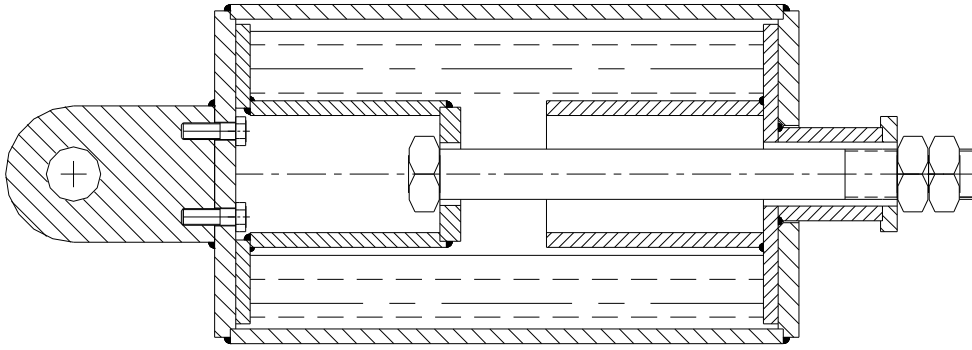

Type No.	Prelaad Kgf	Spring Rate Kgf/mm	Max. Force Kgf
SB – 01	25	1	100
SB – 02	75	3	300
SB – 03	225	9	900
SB – 04	450	18	1800
SB – 05	675	27	2700
SB – 06	900	36	3600
SB – 07	1800	72	7200
SB – 08	2500	100	10000

Units are capable of 75 mm travel in both directions.

Other load and travel combinations may be offered upon request